

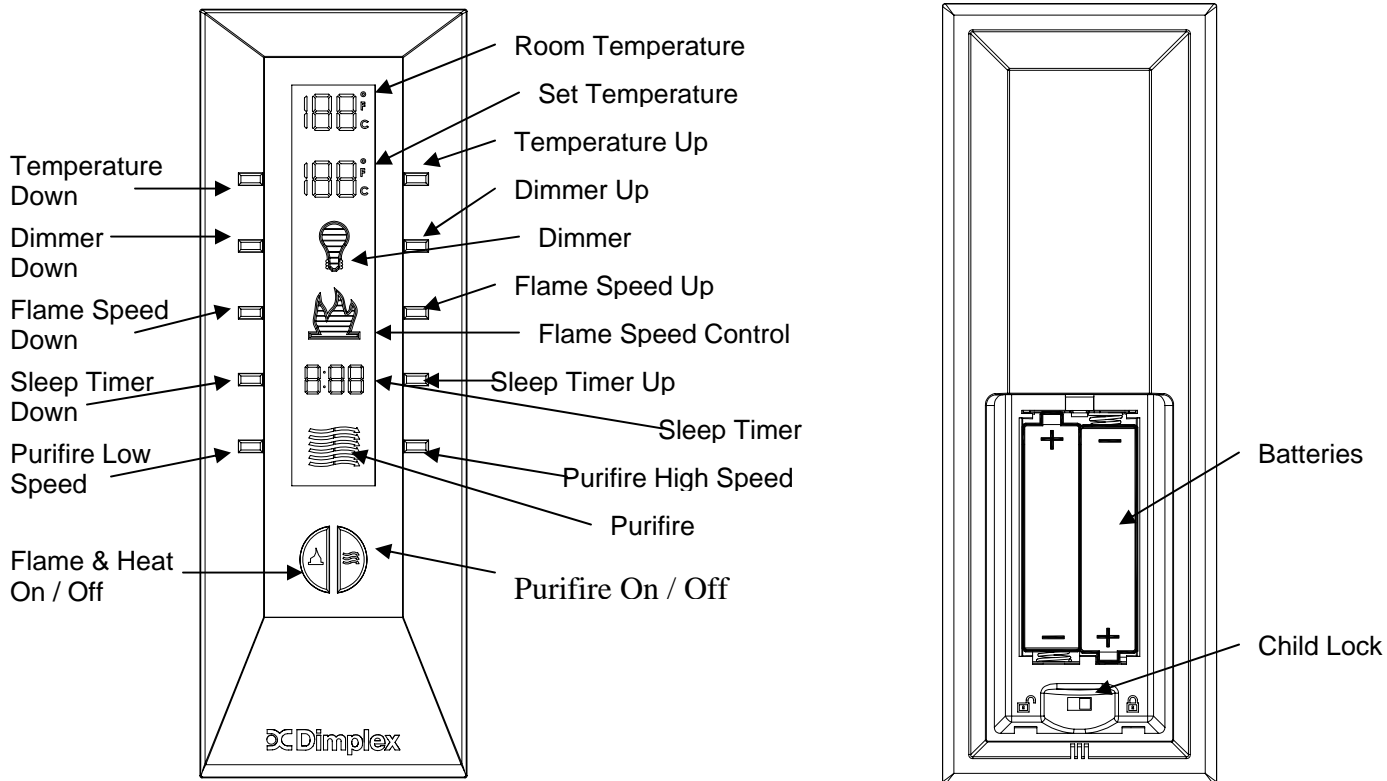

OPERATION

REMOTE CONTROL FUNCTIONS





FLAME/HEAT ON/OFF BUTTON

Press the “Flame/Heat On/Off” button  to turn the Flame/Heat function **ON**. When the “Set Temperature” is higher than the “Room Temperature” the heat will come on. To turn the heat off, lower the “Set Temperature” so that its setting is lower than the “Room Temperature”. The default temperature setting is 72°F (22°C).

NOTE

When using the remote control the heater runs on a thermostat. Press the “Temperature Up” or “Temperature Down” button to adjust the set temperature. Once the desired set temperature is reached the heater will turn **OFF**. The heater will cycle **ON** and **OFF** to maintain the desired set temperature.

PURIFIRE ON/OFF BUTTON

Press the “Purifire™ On/Off” button  to turn the Purifire™ function **ON**. When the Purifire™ function is **ON** the Purifire™ symbol will flash. When off the symbol will be solid. The default setting for the Purifire™ is set at low speed. Press the “Purifire™ On/Off” button  to turn the Purifire™ function **OFF**.

NOTE

To turn the Flame/Heat and Purifire™ **“OFF”** at the same time, press both  control buttons simultaneously.

SET TEMPERATURE

1. Press **“Flame Heat On/Off”** button to turn fireplace on.
2. Press **“Temperature Up”** to raise thermostat.
3. Press **“Temperature Down”** to lower thermostat.
4. Press both **“Temperature Up”** and **Temperature Down”** to change °F to °C.

FLAME SPEED

1. Press the **“Flame/Heat On/Off”** button  to turn the Flame/Heat **ON**.
2. Press the **“Flame Speed Up”** to increase the speed of the flame.
3. Press the **“Flame Speed Down”** to decrease the speed of the flame.

LIGHT DIMMER

1. Press the Flame/Heat button  to turn the Flame/Heat **ON**.
2. Repeatedly press the **“Light Dimmer Up”** or **“Light Dimmer Down”** button to decrease or increase the brightness of the upper lights.

CHILD LOCK

1. Depress tab on the battery cover on the back of the remote transmitter and remove the battery cover.
2. Move **“Child Lock”** tab to the right to lock the remote transmitter.
3. Move **“Child Lock”** tab back to the left to unlock the remote transmitter.
4. Replace the battery cover.

NOTE

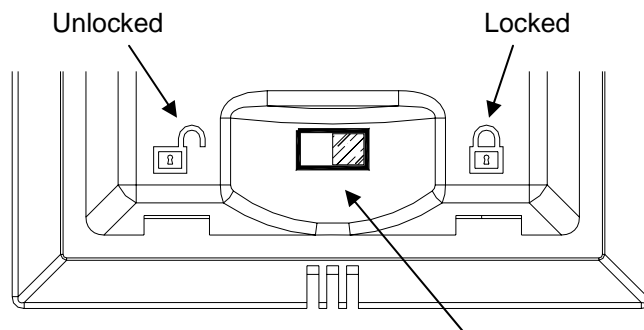

To temporarily unlock the remote transmitter press (in order) **“Temperature Down”** then **“Temperature Up”** then **“Dimmer Down”**.

When the remote transmitter’s backlight is illuminated the **“Child Lock”** is bypassed. When the backlight is off the **“Child Lock”** is re-activated.



PURIFIRE™

The Purifire™ includes a high efficiency filter to help improve the quality of air.

1. Press the  button for the Purifire™ function.
2. Press the “**Purifire Low Speed**” button or the “**Purifire High Speed**” button to select LOW or HIGH.
3. Press the  button to turn the Purifire™ ON, press the  button to turn the Purifire™ OFF.

SLEEP TIMER

The Sleep Timer automatically shuts off the fireplace after a preset time (from 30 minutes to 8 hours).

1. Press the **Flame/Heat On/Off** button to turn the fireplace **ON**.
2. To set the sleep timer press the “**Sleep Timer Up**” button.
3. Set the timer from 30 minutes through 8 hours.
4. The fireplace will automatically turn OFF when the sleep timer reaches 0 minutes.
6. The sleep timer can be cancelled at any time by pressing the “**Sleep Timer Down**” button repeatedly until the sleep timer displays “0”.